

POTSwap™ – HSPA910PS v1.00 Product User Manual



JANUS REMOTE
COMMUNICATIONS

Bulletin	JA16-GSM-UM
Revision	P09
Date	03 Jan 2018

TABLE OF CONTENTS

TABLE OF CONTENTS, LIST OF FIGURES and DISCLAIMER.....	2-3
1. POTSwap General Description	4
2. Plug-In Terminals.....	4
3. Operation	5-6
3.1 Set-up	
3.2 Voice Operation	
3.2.1 Placing Calls	
Manual Telephones	
Automated Dialers	
3.2.2 Receiving Calls	
3.2.3 Call Disconnect	
3.2.4 Call Unconnected Busy	
4. Configuration	7-10
5. External Interface	11-14
5.1 Front Panel:	
Received Signal Strength Indicator	
LED Operational indicators:	
POWER (RED) LED	
CELLULAR (YELLOW) LED	
STATUS (GREEN) LED	
PUSH BUTTONS	
PHONE – FXS Connector	
5.2 Rear Panel:	
Power connectors	
Antenna connectors	
Serial Port	
6. SIM Card Installation	15-16
7. GPS	17
8. Specifications	18
9. Compatible Terminal Block Connectors.....	19
10. Ordering Information	20
11. Accessories	20
12. References.....	20
Revision History.....	20

TABLE OF CONTENTS continued

List of Figures

- Figure 1. POTSwap Block Diagram
- Figure 2. Voice Operation
- Figure 3. Serial Connection
- Figure 4. Front Panel
- Figure 5. RJ11 Jack
- Figure 6. Rear Panel
- Figure 7. Serial Port
- Figure 8. End Panel Screw Removal
- Figure 9. Exposed Circuit Board
- Figure 10. SIM Card Socket
- Figure 11. Re-Assembled Unit

DISCLAIMER

The information contained in this document is the proprietary information of Connor-Winfield Corporation and its affiliates (Janus Remote Communication). The contents are confidential and any disclosure to persons other than the officers, employees, agents or subcontractors of the owner or licensee of this document, without the prior written consent of Connor-Winfield, is strictly prohibited. Connor-Winfield makes every effort to ensure the quality of the information it makes available. Notwithstanding the foregoing, Connor-Winfield does not make any warranty as to the information contained herein, and does not accept any liability for any injury, loss or damage of any kind incurred by use of or reliance upon the information. Connor-Winfield disclaims any and all responsibility for the application of the devices characterized in this document, and notes that the application of the device must comply with the safety standards of the applicable country, and where applicable, with the relevant wiring rules. Connor-Winfield reserves the right to make modifications, additions and deletions to this document due to typographical errors, inaccurate information, or improvements to programs and/or equipment at any time and without notice. Such changes will, nevertheless be incorporated into new editions of this application note.

All rights reserved 2016 Connor-Winfield Corporation

1 POTSwap General Description

The POTSwap allows landline telephones to replace their POTS (plain old telephone service) connection with a wireless cellular connection. Both dial-in and dial-out data and voice applications are supported.

An FXS connection (RJ11 jack) provides complete Central Office emulation including dial tone, ringing and busy signal generation as well as DTMF detection and generation. The POTSwap emulates all the functions of a wired telephone connection, is fully compatible with all common modem standards and can be configured to emulate all international telephone line standards.

Wireless connectivity is provided by the Janus line of Plug-In Terminus terminal modems which provide support for all current mobile network technologies with service available from numerous wireless carriers.

Configuration of the POTSwap can be achieved via a local serial interface connection.

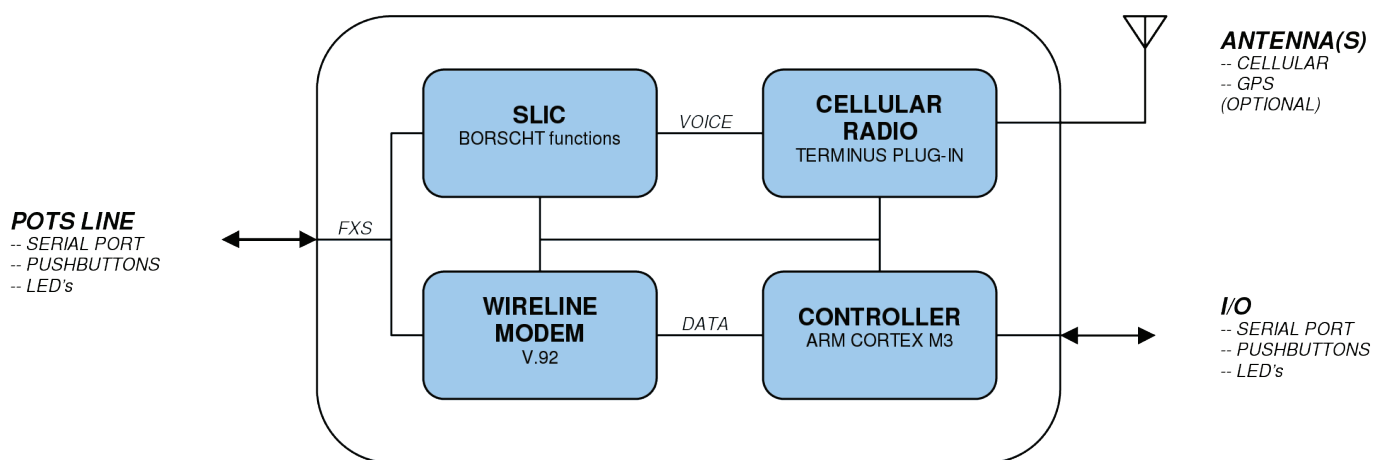

Figure 1 POTSwap Block Diagram

2 Plug-In Terminus

Cellular communication for the POTSwap is powered by Plug-In Terminus terminals. Plug-In Terminus offer easy integration and interchangeability of communication protocols between GSM/GPRS, CDMA, UMTS, EVDO and more by combining full M2M functionality with the flexibility of a standard “plug-in” DIP design. These terminals share the same mechanical footprint and offer users the ability to configure their applications for communications via any cellular protocol. The POTSwap provides one platform that supports current cellular technology with the future in mind.

3 Operation

3.1 Set-Up:

Operating the POTSwap with voice (telephone) equipment can be achieved through the following steps:

1. Gather the required equipment:

- POTSwap
- Power Supply - This can be hard-wired from a user supplied power source via the terminal block header (See section 9 - Compatible Terminal Block Connectors) or using the optional wall transformer (See section 11 - Accessories).
- Cellular antenna - A 5-band ('penta-band') GSM cellular antenna is recommended. An optional cellular antenna is available (See section 11 - Accessories).
- GPS antenna - On units equipped with a GPS antenna connector, a GPS antenna may be connected. (See section 11 - Accessories)
- The HSPA910PS model of the POTSwap requires an activated SIM card. Installation requires a Torx T10 screwdriver (See section 6 - SIM Card Installation).

2. Install the SIM card. The HSPA version POTSwap requires a mini (2FF size) SIM card. See section 6 - SIM Card Installation..

3. Connect a cellular antenna to the SMA connector labeled 'CELLULAR'. This can be a local antenna or a remote antenna connected by a coaxial cable.

4. [Optional] Connect a GPS antenna to the SMA connector labeled 'GPS'. (See Section 7 - GPS.)

5. Connect power to the unit.

Once powered, the unit should show a connection to the cellular carrier within a minute. This will be indicated by a rapidly flashing GREEN 'STATUS' LED, a blinking 'CELLULAR' LED, and a steady signal strength indication on the Received Signal Strength LED stack.



Figure 2 Voice Operation

3.2 Voice Operation

Voice operation requires a standard voice telephone device to be connected to the POTSwap.

3.2.1 Placing calls:

When the connected telephone device is taken off hook, the POTSwap will present an audio dial tone signal. Dialing can proceed with up to 30 digits being accepted. If the Dialing Tone Timeout (30 second default) elapses before the first digit is dialed, the dialing session is ended by an Open Switching Interval (900 millisecond default). If the Dialing Digit Timeout (4 second default) elapses after a dialed digit, dialing is concluded and a call to the dialed number is placed. At any time the number sign ('#') can be dialed and the call is placed immediately, avoiding the Dialing Digit Timeout. Note that if Fixed Format Dialing is enabled, the dialed number must consist of a ten digit phone number that includes the area code, or an eleven number when the first digit is a '1'.



Firmware versions earlier than 150908 only allow dialing fixed format, 10 or 11 digit numbers.



Telephone devices that automatically take the phone off-hook and place a call to a fixed telephone number are compatible with the POTSwap. Dialing digits should not be sent faster than 100 ms per digit, with a minimum DTMF tone duration of 45 ms.

The POTSwap is compatible with DTMF dialing only. Pulse dialing will not work.

3 Operation continued

3.2 Voice Operation continued

3.2.2 Receiving calls:

Incoming calls will cause the POTSwap to generate a ringing signal on the phone line. Taking the connected telephone line off-hook will answer the incoming call. Note that cellular carriers typically impose a 30 second limit on unanswered ringing before a call is transferred to a voice mail system.

3.2.3 Call Disconnect:

A call can always be terminated by placing the connected telephone equipment on-hook. If a cellular call is terminated on the carrier side (the result of a connected party ending the call or due to loss of signal) the POTSwap will use an Open Switching Interval to aid in disconnecting automated type telephone equipment. It removes the voltage from the phone line connection for a short time to signal that the call has been terminated. The OSI interval can be adjusted using the user configuration menu.

3.2.4 Unconnected Busy:

In some instances when dialing a number that is busy, the cellular carriers will not make an audio connection to a busy tone. If this occurs, the POTSwap will generate the busy tone locally for a period defined by the user configurable Busy Dwell Timeout parameter. Following the busy tone, the POTSwap will terminate the call by generating an Open Switching Interval (see section 4 - Configuration).

4. Configuration

Configuration of the POTSwap is available via communications with the SERIAL PORT connection. Configuration can be accomplished by connecting a DTE terminal device (e.g. laptop or desktop computer running a terminal emulator) to the SERIAL port using a straight-thru DB9 serial cable (DB9-M to DB9-F). Newer computers may require a USB to serial port adaptor to complete the connection.

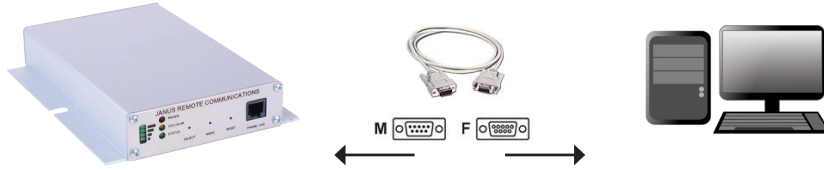

Figure 3 Serial Connection

Default communications protocol is 115200 baud, 8-N-1 (8 data bits, no parity, 1 stop bit) with no handshaking. When the POTSwap is first powered on, it will output something similar to the following:

```
WireLine II Board - POTSwap - [FIRMWARE VERSION]

Audio via digital interface DVI, PCM to SLIC
HE910 Power-Up Mode
Board has SiLabs Wire Line Modem
E911 Voice Calling where system/configuration permit/allow,
  Installer responsible for validation of service

WireLine_Open
  7 Speaker Level
  4 Microphone Level
  1 Echo Cancellation
  25 Transport Mode
  1 TTY Mode
  900 Open Switching Interval
30000 Dialing Tone Timeout
  4000 Dialing Digit Timeout
  6000 Busy Dwell Timeout
  0 Fixed Format Dialing
  0 Fail Over Mode
  2 ADC Gain
  4 DAC Gain
  2 Loop Current Limit
  0 Loop Closure Sensing Type
  8 Loop Closure Threshold
```

The first line will contain the version number of the firmware in a YYYYMMDD (year, month, day) format. Following this are the current configuration settings. Several of these parameters are user configurable and can be adjusted by entering the CONFIG command during the power-up sequence.

About 15 seconds following the application of power, the unit offers a short interval wherein the user can enter the terminal configuration menu. The following text will be output:

```
WireLine II Board - POTSwap
Entering Terminal Mode, 10 seconds to type first command
Type ? for help, Q to exit
FW: HH:MM:SS MTH DY YEAR
READY
```

4. Configuration continued

At this point the user has 10 seconds to enter one of the following commands followed by a line termination ('Enter' key on PC's):

TERMINAL MENU COMMANDS

COMMAND	FUNCTION
?, H	Outputs the current menu options.
Q, QUIT	Exits the menu and causes the POTSwap to proceed with the normal operation.
DEBUG xx	Factory use only
DUMP Adr Len	Factory use only
XMODEM	Download upgrade binary
REBOOT	Restart Application
CONFIG	Configure Settings
IDENTIFY	Display Cellular IMEI (International Mobile station Equipment Identity) and phone number

These commands are NOT case sensitive. Terminal menu commands operate as follows:

?, H: Entering a '?' or 'H' character will output the Terminal menu command menu again. It can be useful if the menu has scrolled off of a screen.

Q ,QUIT: Entering 'Q' or 'QUIT' will exit the DEBUG menu and continue with the normal start-up and operation of the POTSwap.

DEBUG xx: DO NOT USE - Factory use only.

DUMP Adr Len: DO NOT USE - Factory use only.

XMODEM: Used for firmware upgrades.

REBOOT: Entering 'REBOOT' will restart the POTSwap, similar to pressing the RESET button.

CONFIG: Entering 'CONFIG' will cause the configuration menu to be output:

```
Janus Remote Communications - WireLine II Board - POTSwap Configuration
=====
Microphone Level      [4] 0-7
Speaker Level        [7 ] 0-14
Echo Cancellation     [1] 0-1
Open Switching Interval [900 ] 0-1200 ms
Dialing Tone Timeout  [30000] 500-60000 ms
Dialing Digit Timeout [4000 ] 250-15000 ms
Busy Dwell Timeout   [6000 ] 1000-30000 ms
Fixed Format Dialing  [0] 0-1
Fail Over Mode        [0] 0-2

GSM Transport Mode    [25] 12,22,25
GSM TTY Mode          [1] 0-1

SLIC ADC Gain         [2] 0-8
SLIC DAC Gain         [4] 0-8

Loop Current Limit    [2] 0-7
Loop Closure Sense Type [0] 0-1
Loop Closure Threshold [8 ] 0-63

Press M=Modify, D=Defaults, X=Exit and Save, Q=Quit and Discard
```

The configuration menu lists the name of the parameter, the current setting (in brackets), and the range or values of settings available. These settings may vary depending on the model of Plug-In Terminus terminal used in the POTSwap. Following the list of parameters are options for changing the configuration settings or leaving this menu: M, D, X, and Q. These single character command options can be entered in upper or lower case, and no enter key is required.

4. Configuration continued

CONFIGURATION COMMANDS

COMMAND	FUNCTION
M – MODIFY	Enter the parameter modification menu.
D – DEFAULTS	Set all parameters to their default (factory) value.
X – EXIT AND SAVE	Save changes and exit the configuration menu.
Q – QUIT AND DISCARD CHANGES	Discard changes and exit the configuration menu.

M – MODIFY Commands:

Entering an 'M' command will cause the current setting for each parameter to be output, and allows changing the parameter setting. Currently, the following parameters can be modified:

CONFIGURATION PARAMETERS

PARAMETER	DEFAULT	RANGE	FUNCTION
Microphone Level	4	0-7	Sets the outbound audio gain
Speaker Level	7	0-14	Sets the inbound audio gain
Echo Cancellation	1	0-1	Enables the Echo Cancellation feature 0 = Echo Cancellation disabled 1 = Echo Cancellation enabled
Open Switching Interval	900	0-1200 (milliseconds)	Sets the period that the battery voltage is removed from the telephone line following the termination of a call from the carrier side, a dialing timeout, or a locally generated busy tone. (AKA Kewlstart.)
Dialing Tone Timeout ¹	30000 (milliseconds)	500-60000	Sets time limit for first dialing digit to be entered following going off-hook. Exceeding the time limit will cause Open Switching Interval to be generated.
Dialing Digit Timeout ¹	6000 (milliseconds)	250-15000	Sets time limit for time between entering dialing digits. Exceeding the time limit will cause Open Switching Interval to be generated.
Busy Dwell Timeout ¹	6000 (milliseconds)	1000-30000	Sets length of time a busy tone is generated locally on calls where the cellular carrier does not provide an audio connection to a busy tone. The Open Switching Interval will be generated following the busy tone.
Fixed Format Dialing ⁴	0	0-1	Enables Fixed Format dialing. When set to '1' (enabled), only 10 digit (or 11 digits when first digit is a '1') dialing and 911 dialing is allowed. When set to '0' (disabled), any number of dialed digits is accepted once the Dialing Digit Timeout is exceeded. Dialing the number sign ('#') short-cuts the Dialing Digit Timeout and immediately accepts the dialed digits.
Fail Over ⁵	0	0-2	Dial tone availability: 0 - Any network availability, including emergency (911) ONLY. 1 - Home network registration 2 - Home or Roaming registration
GSM Transport Mode	25 ²	12,22,25	Selects network: 12 = GSM 22 = UTRAN 25 = GSM and UTRAN Use 12 = GSM for best in-band DTMF performance.

4. Configuration continued

CONFIGURATION PARAMETERS continued

GSM TTY Mode	1	0-1	TTY MODE enable 0 = TTY mode disabled 1 = TTY mode enabled Improves in-band DTMF transport under certain circumstances
SLIC ADC Gain	2	0-8	Sets outbound audio gain during the initial outbound DTMF dialing. Corrects for distortion using some auto dialers.
SLIC DAC Gain	4	0-8	Sets inbound audio gain. Should be set at 4.
Loop Current Limit ⁴	2	0-7	Sets the telephone loop current limit, from 20mA (0) to 41mA (7) in 3mA steps. Default is 26mA (2).
Loop Closure Sensing Type ³	0	0-1	Sets loop closure (off-hook) sensing type. 0 = current sensing 1 = voltage sensing Use 0 (current sensing) for applications using ringer loads of REN=1 or less. Use 1 (voltage sensing) for ringer loads of REN>1, up to REN=5.
Loop Closure Threshold ³	8	0-63	Sets loop closure (off-hook) sensing threshold. Current sensing: 1.27 ma/unit (e.g. '8'=10.26 mA) Voltage Sensing: 1.45 V/unit (e.g. '10'=14.50 V) Recommended settings: REN<=1: Current sensing; threshold=8 [default] For REN>1 to REN=5: Voltage sensing; threshold=10

Notes:

1. Available on firmware versions 140725 and higher
2. 12 on firmware versions 131011 and lower
3. Available on firmware versions 140207 and higher
4. Available on firmware 150908 and higher.
5. Available on firmware 160714 and higher.

D – DEFAULTS Command:

Entering the 'D' command will change all of the settings back to the factory defaults. These settings will not be saved unless the 'X' Exit and Save command is issued. Older versions of firmware will request that the POTSwap be restarted to effect the changes; current versions will restart automatically.

X – EXIT AND SAVE Command:

Entering the 'X' command will save any changes made using the 'M' Modify or 'D' Defaults commands. This will also exit the menu system and requires that the POTSwap be restarted either by pressing the RESET push button or by un-powering and re-powering the unit.

Q – QUIT AND DISCARD Command:

Entering the 'Q' command will discard any changes made using the 'M' Modify or 'D' Defaults commands. This will also exit the menu system and requires that the POTSwap be restarted either by pressing the RESET push button or by un-powering and re-powering the unit.

5. External Interfaces

5.1 Front Panel

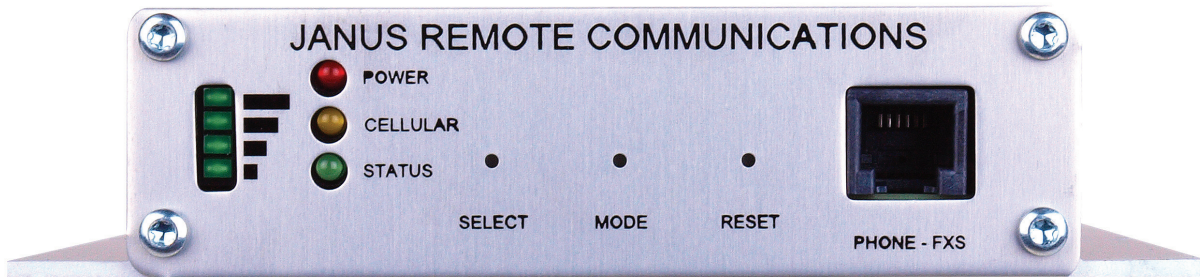

Figure 4 Front Panel

Received Signal Strength Indicator

A stack of 4 green LED's on the left side of the front panel indicate the relative signal strength of the cellular radio signal. It is analogous to the 'bars' display on a cellular telephone handset.

RSSI INDICATOR

LED's ILLUMINATED	SIGNAL STRENGTH	RSSI (dBm)
4	Excellent	-73 or better
3	Good	-83 to -74
2	OK	-93 to -84
1	Marginal	-109 to -94

If no signal is detected, the LED's on the stack alternately illuminate from bottom to top and back in a 'scanning' manner.

GPS INDICATOR

The bottom (#1 'Marginal') LED on the RSSI indicator will blink several times for 1 second every 10 seconds to indicate a GPS location fix is available. This indication is independent of the cellular signal strength indication. See section 7 - GPS.

LED Operational indicators

LED	LED COLOR	INDICATION
POWER	Red	Power status
CELLULAR	Yellow	cellular radio status
STATUS	Green	System status

General status conditions can be inferred as follows:

Green and Yellow LED continuously ON: during initialization (following the application of power or a manual RESET).

Yellow LED blinks every 2.5s – wireless registered on network.

Yellow LED ON - when cellular call connected.

Green LED fast blink - when on hook (no call in progress)

Green LED - ON when off hook (during call)

POWER (RED) LED

LED STATUS	INDICATION
ON	System is powered
OFF	System has no power
Blinking	System Fault

5. External Interfaces continued

CELLULAR (YELLOW) LED:

LED STATUS	CELLULAR RADIO
OFF	Off
ON	Not registered - or - Call active
Blinking 1sec on + 2 sec off	Registered in idle

* When the CELLULAR LED stays on (not registered) for more than a few minutes after powering the POTSwap, it is usually an indication of a poor antenna connection or a problem with the activation on the cellular network. Check that the SIM card is properly installed and that it has valid activation with a cellular carrier.

STATUS (GREEN) LED

LED STATUS	INDICATION
ON	Phone line 9RJ11) is OFF-HOOK (also during initialization)
Blinking fast (12.5 Hz)	Phone line (RJ11) is ON-HOOK
Blinking slow (1 Hz)	Initializing

PUSH BUTTONS

Three push buttons are provided on the front panel of the POTSwap. These can be operated with a small diameter object such as a paperclip. There is tactile feedback that indicates when the push button has been operated.

Applying pressure to the push buttons beyond the point at which they actuate can damage the switch.

Currently the SELECT and MODE push buttons are not supported. The RESET push button performs the same function as powering the unit off and then on; the configuration parameters are not affected.

PUSH BUTTON FUNCTIONS

PUSH BUTTON	FUNCTION
SELECT	Future Use
MODE	Future Use
RESET	System Restart

PHONE – FXS Connector:

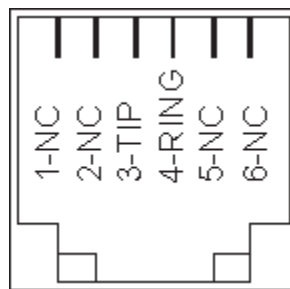

Figure 5 RJ11 Jack

A standard RJ11 jack (6P2C – 6 position 2 conductor) supports the landline telephone interface.

This jack simulates what would be provided by a land-line based telephone central office, including power, ringing signal and voice transport.

Any standard telephone device can be connected to this connector.



Under no circumstances should the PHONE – FXS connector be connected to another powered telephone line – e.g. a telephone wall jack or PBX line.

5. External Interfaces continued

5.2 Rear Panel



Figure 6 Rear Panel

Power connectors:

Two types of power connector are provided on the POTSwap. These two connectors are connected directly together internally, and are simply provided as a user convenience.



DO NOT APPLY POWER TO BOTH CONNECTORS SIMULTANEOUSLY

The negative terminal of the power supply is connected to the enclosure.

Power supply range can be found in the Specifications section.

Terminal Block Header: This is an industry standard 5.08 mm header that accepts a variety of terminal blocks, including screw terminal, spring clamp and crimp terminal type. See Section 9 – Compatible Terminal Block Connectors.

Circular Jack: The circular DC jack has a 6 mm hole diameter and a 2 mm center pin. It is designed to accept a 5.5 mm diameter plug with a 2.1 mm center hole and a 8.5 mm barrel length. The center pin is the positive terminal.

Antenna Connectors:

CELLULAR: A standard 50 ohm SMA connector is provided for connecting a cellular antenna. The placement of the antenna affects connectivity; a remote antenna location may be necessary in some situations.

GPS: A standard 50 ohm SMA connector is provided for connecting a GPS antenna. The GPS connector is available on the HSPA910PS 'TAGFNG' version, and requires firmware version 160714 to operate. See section 7 - GPS.



The GPS connector provides a 2.85V bias voltage for active antennas.

Serial Port:

The female DB9 connector is configured as DCE (Data Communications Equipment) and provides a data path for user configuration, firmware uploads and debug support.

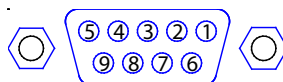

Figure 7 Serial Port

5. External Interfaces continued

5.2 Rear Panel continued

SERIAL PORT PINS

PIN NUMBER	FUNCTION	NEMONIC	DIRECTION
1	CARRIER DETECT	CD	OUTPUT
2	RECEIVED DATA	RX	OUTPUT
3	TANSMITTED DATA	TX	INPUT
4	DATA TERMINAL READY	DTR	INPUT
5	GROUND	GND	-----
6	DATA SET READY	DSR	OUTPUT
7	READY TO SEND	RTS	INPUT
8	CLEAR TO SEND	CTS	OUTPUT
9	RING INDICATOR	RI	OUTPUT

Default communications protocol is 115200 baud, 8-N-1 (8 data bits, no parity, 1 stop bit) with no handshaking.

SERIAL COMMUNICATION PROTOCOL:

PARAMETER	SETTING
Baud rate	115200
Data bits	8
Parity bit	None
Stop bits	1
Handshaking	None

6. SIM Card Installation

The POTSwap model HSPA910PS requires the installation of an activated SIM card for operation. The SIM card installation can be performed as follows:

Requirements:

- POTSwap containing a Plug-In Terminus with SIM card socket (model HSPA910PS).
- Mini (2FF size) SIM card
- T10 TORX screwdriver

Procedure:

1. Disconnect all external cables from the POTSwap. Remove the four TORX (T10) screws from the rear enclosure panel (the end that contains the POWER and SERIAL PORT connectors).



Figure 8 End Panel Screw Removal

2. Slide the circuit board out of the case.

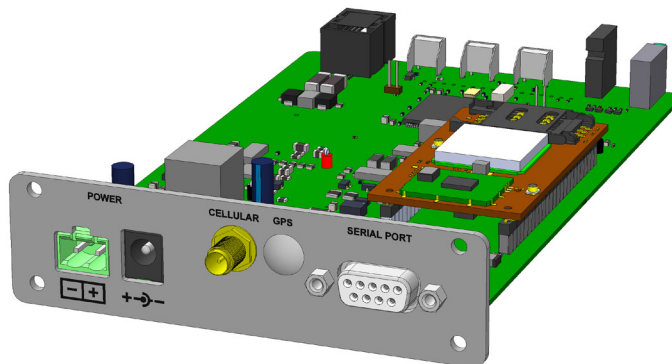

Figure 9 Exposed Circuit Board

6. SIM Card Installation continued

3. With the circuit board exposed, the SIM card socket is on the cellular radio module. Slide the card holder (the top section of the SIM card socket) towards the outer edge of the POTSwap to unlock it (as shown in the figure below). The card holder is hinged on the outer edge - lift it up and slide the SIM card into the holder, flat end first, chamfered end up. The gold contacts on the SIM card will face down when the SIM card holder is closed. Slide the card holder towards the center of the POTSwap to lock the card in place.

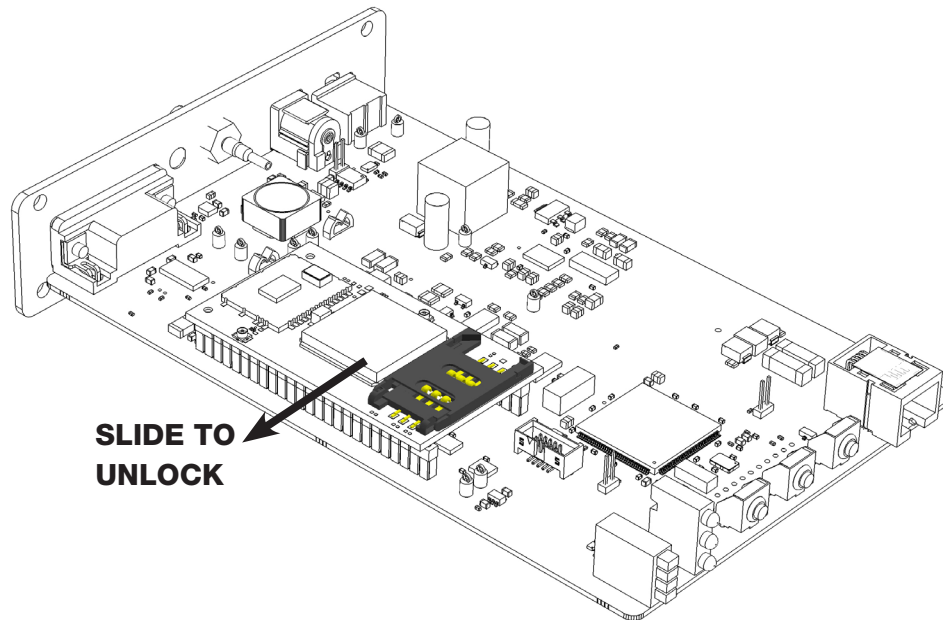

Figure 10 SIM Card Socket

4. Slide the board back into the enclosure making sure that the front panel components align properly with the enclosure openings. Install the four TORX screws and tighten.



Figure 11 Re-Assembled Unit

7. GPS

7.1 GPS Operation

POTSwap models have a GPS antenna connector installed on the back plate and offer the ability to provide enhanced location information to emergency (911) operators. A suitable GPS antenna must be used and the antenna must be properly located to receive the GPS signals.

The GPS operation is automatic, and is independent of the cellular radio operation. When the unit has acquired a GPS location fix, the bottom LED on the RSSI indicator will blink several times for 1 second at 10 second intervals. This indication is independent of the cellular signal strength indication. See section 5.1 – Front Panel. A GPS location fix should be available within a few minutes of operation under normal conditions.

7.2 GPS Antenna

For best results, it is recommended that an active GPS antenna be used with the POTSwap. The GPS antenna connector provides a 2.85V bias voltage to power an active antenna, and should easily be able to supply the 5 to 25mA of current that a typical active GPS antenna requires. Any standard off-the-shelf active GPS antenna that will operate at the 2.85V bias voltage should suffice. See section 11 – Accessories.

7.3 GPS Antenna location

The ideal GPS antenna position would be an outdoors location with a clear view of the sky to the horizon in all directions, with no obstructing structures or foliage. A higher antenna placement usually gives a better view of the sky over surrounding obstructions. In the northern hemisphere, a southern sky view is preferable over a northern sky view. If the antenna must be indoors, placement as near as possible to a window is preferable. Receiving a GPS location fix deep inside buildings or in dense urban environments (“street canyons”) is normally not possible.

7.4 GPS Troubleshooting

With a terminal attached to the SERIAL port, debug messages are available that can be used to monitor the GPS operation. See section 4 – Configuration, for information on attaching a terminal to the SERIAL port.

There are several types of debug messages output during normal operation. The message with the GPS information includes “\$GPSACP:” near the beginning of the output line, and is output about once per minute. The \$GPSACP message conveys 11 terms, separated by commas:

UTC	UTC time (hhmmss.sss)
latitude	format is ddmn.mmmmm N/S
longitude	format is ddmn.mmmmm E/W
hdop	x.x - Horizontal Dilution of Precision
altitude	x.x Altitude - mean-sea-level (geoid) in meters
fix	0 or 1 - Invalid Fix; 2 - 2D fix; 3 - 3D fix
cog	ddd.mm - Course over Ground (degrees, True)
spkm	x.x Speed over ground (Km/hr)
spkn	x.x- Speed over ground (knots)
date	ddmmyy Date of Fix.
nsat	nn - Total number of satellites in use, 00..12

The final term can be used to provide some useful information about the quality of the GPS antenna system being used. Generally, the better the antenna system, the greater the number of satellites will appear in the ‘nsat’ term. Though it varies over time, the typical maximum number of satellites available is 10. A minimum of 4 is required to get a location fix, and numbers of 8 or more indicate an excellent antenna system.

With no location fix, the \$GPSACP message will appear as follows:

```
[$GPSACP: ,,,,,,1,,,,]
```

This would be expected after the unit has powered up but before a location fix is acquired. It would also be indicative of a poor antenna system if it was still being reported after several minutes of operation.

A typical fix might appear similar to the following:

```
[$GPSACP: 183117.000,4147.6251N,08815.5097W,1.25,191.0,3,191.69,0.12,0.06,290716,07]
```

In this example the ‘nsat’ term indicates that 7 satellites are being used.

8. Specifications

Interfaces

Parameters	Description
Modem/Telephone	RJ11 connector (FXS)
Serial	DB9 female DCE connector (user terminal interface for configuration and firmware upload.)
Cellular Antenna	SMA connector, 50 ohms.
GPS Antenna	50 ohm SMA w/ 2.85V bias (on TAGFNG models only)
Power Input	7-15 Vdc; 22W with two input alternatives: <ul style="list-style-type: none">-- 6mm DC power jack with 2mm center pin positive-- 5.08mm (0.200") terminal block header (accepts screw clamp and crimp connector type terminal blocks)

Features

Parameters	Description
SLIC	Performs all BORSCHT functions: <ul style="list-style-type: none">Battery supply to subscriber lineOvervoltage protectionRinging current supplySupervision of subscriber terminalCoder and decoderHybrid, 2 wire to 4 wire conversionTesting DTMF encoding and decoding REN=5 at 100 ft. (30m)
Voice	Voice over cellular
Cellular Connection	HSPA910PS model supports GSM/GPRS/EDGE and WCDMA/HSPA. Frequency Bands: GSM / GPRS / EDGE: 850, 900, 1800, 1900 MHz UMTS / HSPA: 800/850, 900, AWS1700, 1900, 2100 MHz
SIM Card	Mini (2FF size) SIM card
Push Buttons	SELECT, MODE, and RESET
LEDs	Power, Status, Cellular Link and Signal Strength
Dimensions (L x W x D)	6.5 in (165mm) x 5.2 in (132mm) x 1.2 in (30mm)
Weight	15 oz (425 g)
Mounting	Integrated mounting brackets (optional)

Environmental

Parameters	Description
Operating Temperature	-40° C to +60° C (-40° F to 140° F) (Note: Operating temperature may be further limited by specific Plug-In Terminus terminal)
Relative Humidity	5% to 95% (non-condensing)

9. Compatible Terminal Block Connectors

The POTSwap has a 0.200" terminal block header, also referred to as a 5.08 mm Eurostyle connector. It supports a variety of plug-in terminal block types, including screw terminal, spring contact and crimp terminals.

Manufacturers for these terminal blocks include:

- Camden Electronics
- FCI Electronics
- Molex
- OST (On Shore Technology)
- Phoenix Contact
- TE Connectivity (Tyco/Buchanan)
- Weidmüller
- Würth Elektronik

Below is a small sample of compatible connectors:

TYPE	MANUFACTURER	PART NO.	DESCRIPTION
Screw Terminal	TE Connectivity ¹	796634-2	vertical screw, horizontal plug
	TE Connectivity	1986484-2	horizontal screw, vertical plug
	Molex	395300002	vertical screw, horizontal plug
	Molex	395332002	horizontal screw, vertical plug
	Weidmuller	1943580000	vertical screw, horizontal plug
Spring Clamp	Weidmuller	1013680000	orange
	Weidmuller	1013430000	black
Crimp Housing & Contacts	TE Connectivity	1986160-2	crimp housing, green
	TE Connectivity	965901-1	crimp terminal, 20-17 AWG
	TE Connectivity	965899-1	crimp terminal, 13-17 AWG
	Weidmuller	1610490000	crimp housing, orange
	Weidmuller	1711960000	crimp housing, black
	Weidmuller	1604250000	crimp contact, 24-22 AWG
	Weidmuller	1567060000	crimp contact, 20-17 AWG
	Weidmuller	1567070000	crimp contact, 16-14 AWG

Note:

¹ - This component is available from Janus Remote Communications. See 'TERMINAL BLOCK' in Section 10.

POTSwap™ – HSPA910PS v1.00

Product User Manual

10. Ordering Information

POTSwap MODEL	DESCRIPTION
HSPA910PS v1.00 TAUVNG	HSPA+/UMTS/EDGE/GPRS/GSM (AT&T and PTCRB)
EVDO910PS v2.00 TAUVNG	EV-DO (Sprint)
EVDO910PS v3.00 TAUVNG	EV-DO (Verizon)

11. Accessories

The following accessories are available from Janus Remote Communications:

ACCESSORY NUMBER	DESCRIPTION	JANUS STORE PART
POWER SUPPLY	Wall transformer with circular DC connector, 12V 2A	MC-0004
CELLULAR ANTENNA	Indoor 5-band GSM/CDMA/UMTS 3G	ANT-0003
GPS ANTENNA	Active Antenna, Magnetic Mount, Waterproof, 10 ft. SMA	ANT-0030

12. References

JA03-UM - Terminus Plug-In Products User Manual

Accessory Kit available at Store



Revision History

Revision	Revision Date	Note
P00	11/23/13	Preliminary POTSwap User Manual Release
P01	03/03/14	Overall Product Update/Changes
P02	05/08/14	Updated to GSM Version Only (HSPA910PS)
P03	08/19/14	Updated Voice Operations and Configurations
P04	08/11/15	Update to Enclosure and Dimensions
P05	09/05/15	Operation, Configuration & Interfaces
P06	08/01/16	Added GPS Information
P07	08/31/16	Added SIM Card Size
P08	07/13/17	Added v2.00 EVDO version to Ordering Information
P09	01/03/18	Updated Part Numbers and Accessories

JANUS REMOTE
COMMUNICATIONS

Division of The Connor-Winfield Corporation
2111 Comprehensive Drive • Aurora, Illinois 60505
630.499.2121 • Fax: 630.851.5040

www.janus-rc.com

© Copyright 2020 Janus Remote Communications.
POTSwap is a registered trademark of Janus.

All Rights Reserved *Specifications subject to change without notice*
See website for latest revision. Not intended for life support applications.